

9509

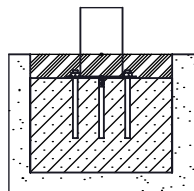

9509N

9509N

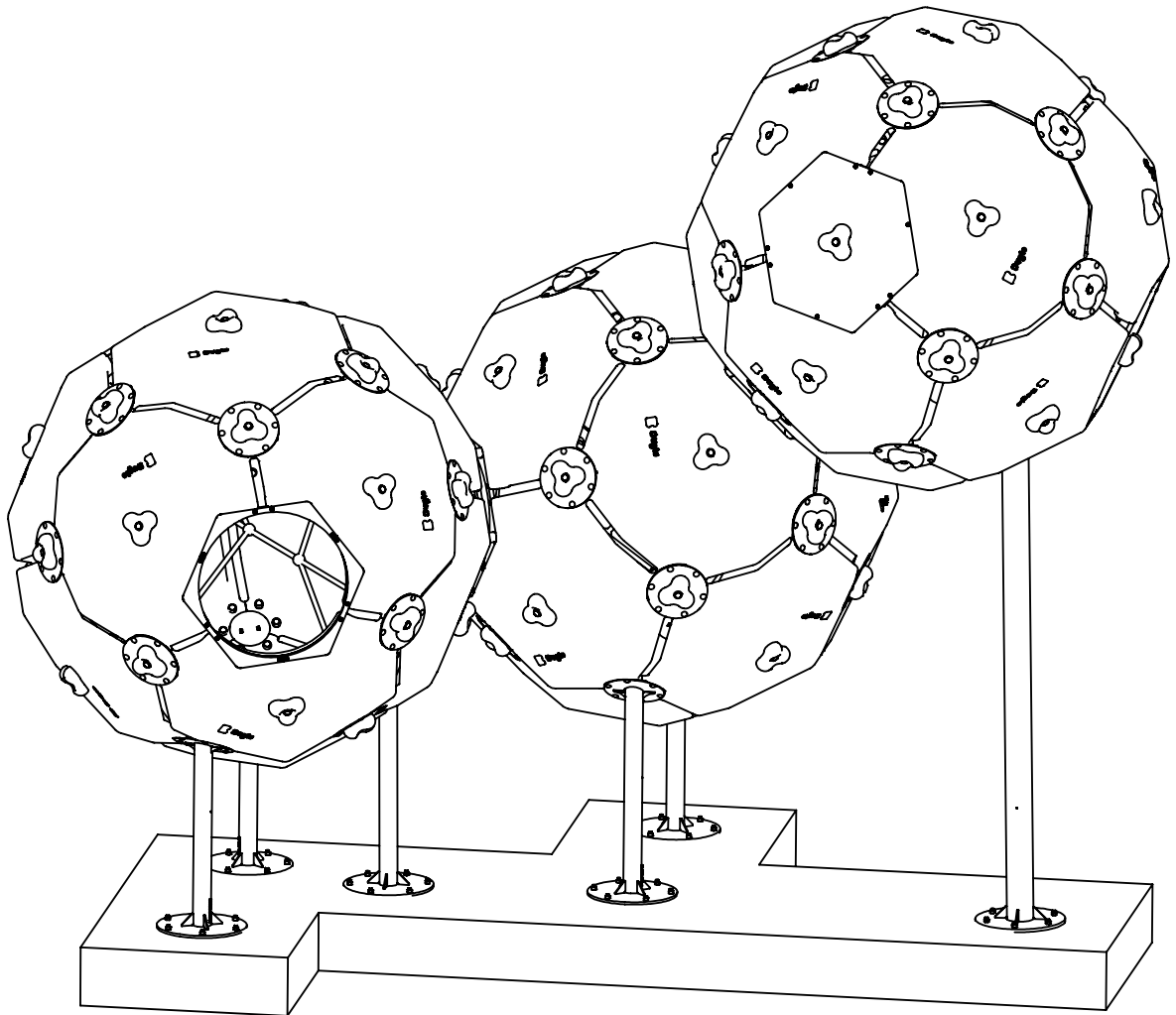
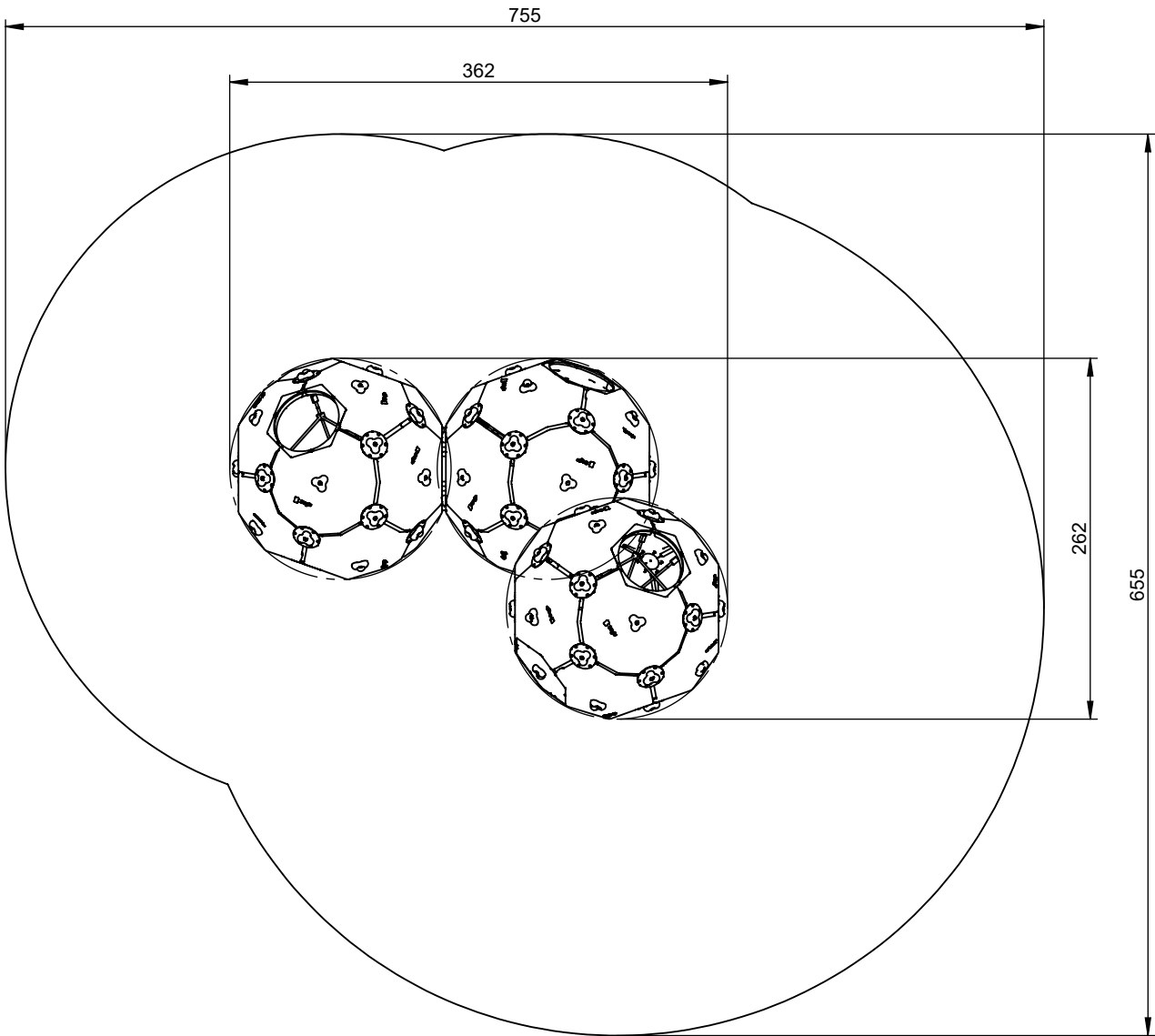
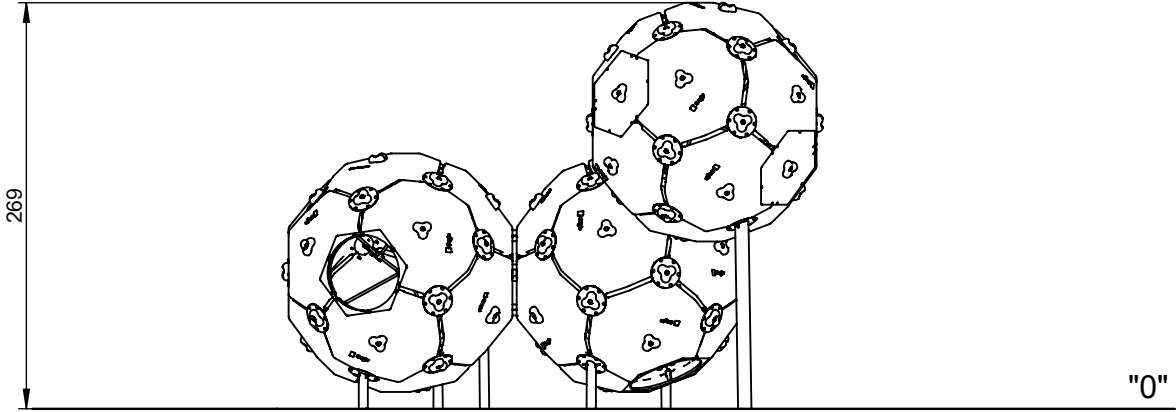

9509N

3

B25 0,81m

min. 48H

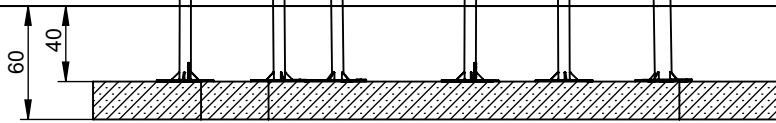
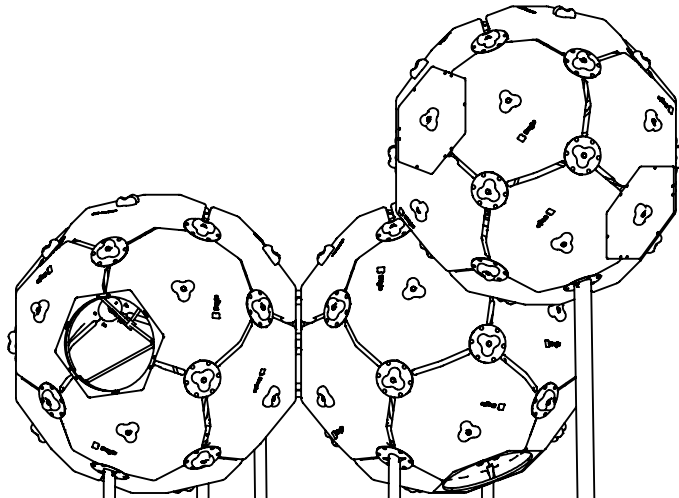
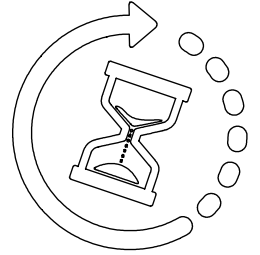
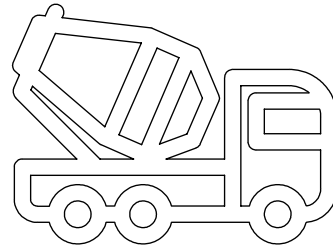
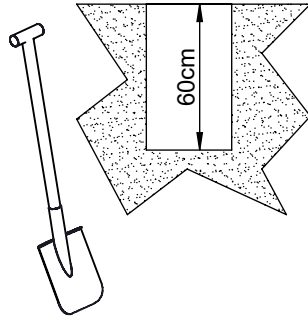

"0"

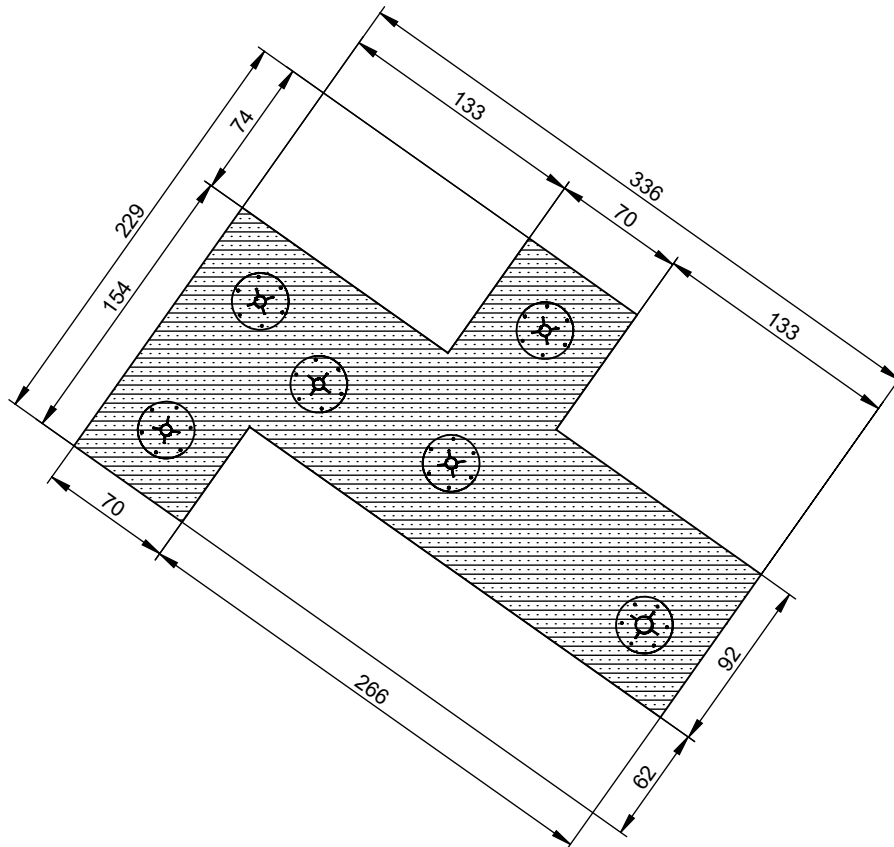

9509N



"0"

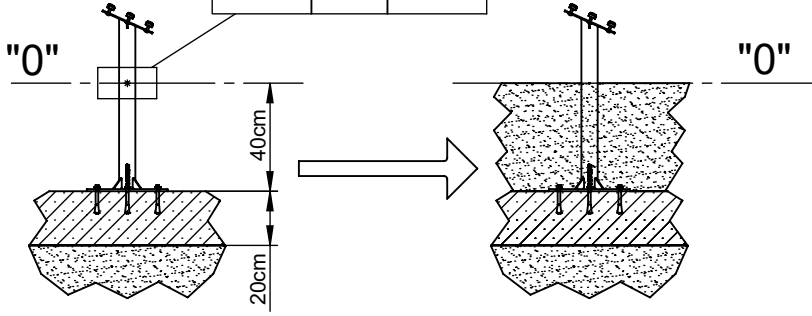

Nr	Element		
61		-	KL105 (OC)

